

HEATIT Z-HAN B

Installers manual

Firmware 1.0

01.11.2022

Ver 2022-A

Art.no. 45 124 96

heatit



TABLE OF CONTENTS

1. Introduction
2. Statement regarding products from multiple manufacturers
3. Behaviour within the Z-Wave™ network
4. Quick Start
5. Add/Remove
 - 5.1 Method 1: Standard (Manual)
 - 5.2 Method 2: SmartStart (Automatic)
6. Factory Reset
7. Startup
8. LED blinking patterns description
9. QR-Code Placement (DSK)
10. Security
11. Node Information Frame
12. Associations
 - 12.1 Setting and Removing Associations
13. Association Groups
14. Configuration Parameters
15. Command Classes
 - 15.1 Meter Command Class
 - 15.2 Indicator Command Class
16. Supported Command Classes
 - Product info

1. INTRODUCTION

Heatit Z-HAN B is a Z-Wave™ HAN sensor for AMS meters (Smart meters). The Heatit Z-HAN B works with Norwegian AMS meters.

Heatit Z-HAN B is equipped with an RJ45 port for connection to the AMS meter. The Heatit Z-HAN B can be powered through the RJ45 port by most AMS meters, but it also has a 5V micro USB port for external power supply.

2. STATEMENT REGARDING PRODUCTS FROM MULTIPLE MANUFACTURERS

Please read this before installation

This device may be used with all devices certified with the Z-Wave Plus™ certificate and should be compatible with such devices produced by any manufacturer. Every primary controller is different depending on the manufacturer, their target audience and intended use/application. Please review the functionalities implemented by the primary controller you intend to use with our Z-Wave Plus certified device to ensure that it provides the necessary controls to take full advantage of our product's capabilities.

3. BEHAVIOUR WITHIN THE Z-WAVE™ NETWORK

This device may be operated within any Z-Wave network with Z-Wave-certified devices from other manufacturers. All non-battery-operated nodes within the network will act as repeaters regardless of manufacturer to increase the reliability of the network. On delivery, the device does not belong to any Z-Wave network. The device needs to be added to an existing network to communicate with the other devices within it. Devices may also be removed from a network. The add/remove processes are initiated by the primary controller of the Z-Wave network.

4. QUICK START

1. Contact your energy company to activate your HAN-port.
2. Connect power to the Z-HAN sensor with a micro USB cable.
3. Set the primary controller to add mode (security/non-security).
4. Press the reset button on the HAN sensor 3 times in a rapid sequence. Heatit Z-HAN is now included in your Z-Wave network.
5. Open your main fuse box.
6. Plug the RJ45 cable into the Energy meter and the Z-HAN sensor.



5. ADD/REMOVE

Please read this before installation

The primary controller/gateway has a mode for adding or removing devices. Please refer to your primary controller manual on how to set the primary controller in add/remove mode. The device may only be added or removed from the network if the primary controller is in add/remove mode. When the device is removed from the network, it will **NOT** revert to factory settings.

An always listening node must be powered continuously and reside on a fixed position in the installation to secure the routing table. Adding the device within a 2m range from the gateway can minimize faults during the Interview process.

There are two ways to add the device to a Z-Wave network.

5.1 Method 1: Standard (Manual)

Add/remove mode is indicated on the device by a blinking green LED. It indicates this for 90 seconds until a timeout occurs, or until the module has been added to/removed from the network.

To start the configuration process, press the reset button 3 times in rapid succession. The LED will light up in green for 3 seconds if adding/removing is successful. The device is now ready for use with default settings.

NB! When the device is removed from the gateway, the parameters are not reset. To reset the parameters, see Chapter 6 "Factory reset".

If inclusion fails, please perform a "remove device" process and try again. If inclusion fails again, please see Chapter 6 "Factory reset".

5.2 Method 2: SmartStart (Automatic)

SmartStart enabled products may be added to a Z-Wave network by scanning the Z-Wave QR-Code on the product if your primary controller supports SmartStart inclusion. No further action is required and the SmartStart product will be added automatically after being powered on within range of the primary controller.

6. FACTORY RESET

Press and hold the reset button. After 3 seconds the LED will start to blink in green. After 20 seconds the LED will shine solid green for 3 seconds. You may now release the button.

Please use this procedure only when the network primary controller is missing or otherwise inoperable.

7. STARTUP

After powering up the device for the first time, all the parameters will have default settings.

8. LED BLINKING PATTERNS DESCRIPTION

The device supports numerous LED blinking patterns to make it as easy as possible to identify what the device is doing.

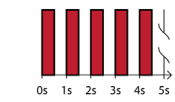
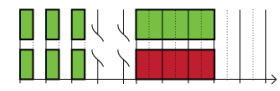
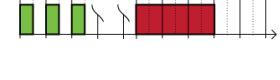
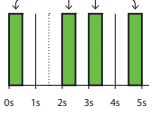
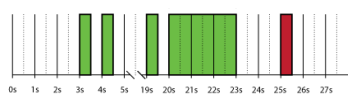
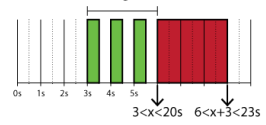
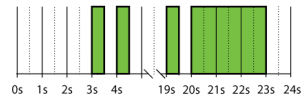
| | |
|--|---|
| <p>Device Not in Network The LED will flash in red when the device is not added to a Z-Wave network</p> |  |
| <p>Add/Remove When device enters add/remove mode the LED will flash green.</p> <p>If successful, the LED will light up in green for 3 seconds. If unsuccessful, the LED will light up in red for 3 seconds.</p> | <p>Successful </p> <p>Unsuccessful </p> |
| <p>Communication The device should blink green every time it sends data over Z-Wave</p> | <p>Z-Wave Data transmission indication</p>  |
| <p>Factory Reset If the button is pressed for more than 3 seconds, the GREEN LED will start flashing. When the button has been pressed for 20 seconds, the GREEN LED will light up for 3 seconds.</p> <p>Figure 1 (success) Within the 3 second period the button must be released. If the button is released within this period, the device will reset and start flashing because it is not included in a gateway.</p> <p>Figure 2 (fail) If the button is released before the 3 second period, the device will indicate fail by turning RED LED on for 3 seconds.</p> <p>Figure 3 (fail) The button MUST be released between 20 and 23 seconds for local reset to take place. If held longer, the device will ignore the command.</p> | <p>Figure 1</p>  <p>Figure 2</p> <p>Released @ x seconds</p>  <p>Figure 3</p>  |

9. QR-CODE PLACEMENT (DSK)

The QR-Code is needed when including a device using S2 security or SmartStart. The DSK can be found in the QR-Code and is located;

- On the product.
- On the Quick Guide.
- On the gift box.

10. SECURITY

S2 security enhances Z-Wave Plus with an additional layer of AES 128-bit encryption of the wireless Z-Wave communication to prevent hacking and man-in-middle attacks on the home network. This device supports S2 and has a Z-Wave DSK QR-Code label that may be used when the module is added to the Z-Wave home network. The primary controller will ask for a 5-digit code, which can be found underneath the QR-Code.

11. NODE INFORMATION FRAME

The node information frame is the "business card" of a Z-Wave device. It contains information about the device type and its technical features. The add and remove procedure of the device is confirmed by sending out a node information frame. Besides this, it may be necessary for certain network operations to send out a node information frame.

12. ASSOCIATIONS

Z-Wave devices interact with other Z-Wave devices. The relationship between one device controlling another device is called an association. In order to control a subordinate device, the controlling device needs to maintain a list of devices that will receive controlling commands. These lists are called "Association Groups". They are always related to the specific event triggered (e.g., sensor reports). In case the event is triggered, all devices stored in the respective association group will receive a joint wireless command.

12.1 Setting and Removing Associations

Associations may be assigned and removed via Z-Wave commands. Please refer to your primary controller/Z-Wave gateway for more information.

13. ASSOCIATION GROUPS

| MULTILEVEL SWITCH DEVICE | DESCRIPTION |
|--------------------------------|--|
| Group 1 Lifeline | Lifeline. (Normally used by the Z-Wave Controller) Sends: - Device Reset Notification - Indicator Report - Meter Report - Multilevel Sensor Max nodes in group: 5 |
| Group 2 Meter report | - Meter report (kWh) - Meter report (W) Max nodes in group: 5 |

14. CONFIGURATION PARAMETERS

Z-Wave products are supposed to work out of the box after inclusion. Some device configuration may, however, alter the functionality to better serve user needs or unlock further enhanced features. All the parameters except 9 and 10 do not feature altering capabilities, advances or read only flag. Parameter 9 and 10 are only read parameters.

| PARA NO | PARA SIZE | NAME | SHORT DESCRIPTION / COMMENT | MINIMUM | MAXIMUM | DEFAULT | DESCRIPTION OF VALUE |
|---------|-----------|------------------------------------|--|---------|-------------------|------------------|---|
| 1 | 4 | Meter report hysteresis for W. | Set the Meter Report hysteresis for Watts. | 0 | 100 000 | 200 | 0 = Disabled. 1 - 100 000W. Default 200W. |
| 2 | 2 | Meter report hysteresis for V. | Set the Meter Report hysteresis for Volts. | 0 | 420 | 5 | 0 = Disabled. 1 - 420V. Default 5V. |
| 3 | 2 | Meter report hysteresis for A. | Set the Meter Report hysteresis for Amps. | 0 | 65 535 | 20 | 0 = Disabled 1 - 65 535A (0.1 - 6553.5A) Default 20 (2A). |
| 4 | 2 | Meter report interval for W. | Time Interval between consecutive W reports. | 10 | 65 535 | 10 | 10 - 65 535 seconds. Default 10 seconds. |
| 5 | 2 | Meter report interval for V and A. | Time interval between consecutive meter reports. This parameter will issue: V and A. | 10 | 65 535 | 300 | 10 - 65 535 seconds. Default 300 seconds (5 minutes). |
| 6 | 2 | Temperature report interval. | Time interval between consecutive temperature reports. | 30 | 65 535 | 300 | 30 - 65 535 seconds. Default 300 seconds (5 minutes). |
| 7 | 1 | Temperature report hysteresis. | Temperature reports based on change in temperature from last report. NB! 0.5°C increments. | 0 | 100 | 10 | 0 = Disabled. 1-100 (0.1-10.0°C). Default 10 (1°C). NB! This parameter has 0.5°C increments. |
| 8 | 1 | Sensor calibration. | Manually calibrates the sensor ±6°C. | -60 | 60 | 0 | -6.0°C to 6.0°C. Calibrates the sensor by ±6°C. NB! To set a negative value, use 256 and subtract the desired value. |
| 9 | 4 | Serial | First half of the meter point serial number. Read only | 0 | 4 294.9 67 295 | 1 718 972 025 | Shows the first half of the meter point serial number. NB! This parameter is read only. |
| 10 | 4 | Number | Last half of the meter point serial number. Read only | 0 | 4 294.9 67 295 | 1 835 363 685 | Shows the last half of the meter point serial number. NB! This parameter is read only. |

15. COMMAND CLASSES

Besides the mandatory command classes, the device has support for the following command classes:

15.1 Meter Command Class

The device supports Meter Command Class Get, and the Z-HAN sensor will only respond on supported electric meter scales: kWh (accumulated), W (power), V (voltage) and A (current). The device will report when asked:

Rate import: Import (0x01)
Meter type: Electric meter (0x01)
Precision: 1 decimal (0x01)

| TYPE | SCALE | VALUE | SIZE | PRECISION | REPORT HYSTERESIS |
|----------|-------|-------|------|-----------|--|
| Electric | kWh | 0x00 | 4 | 2 | On change from AMS meter. |
| Electric | W | 0x02 | 4 | 0 | 200W / 10s, configurable by parameter. |
| Electric | V | 0x04 | 2 | 1 | 5V / 300s, configurable by parameter. |
| Electric | A | 0x05 | 2 | 1 | 2A / 300s, configurable by parameter. |

15.2 Indicator Command Class

The device supports Indicator Command Class.

The indicator Command Class will turn ON/OFF internal LED.

16. SUPPORTED COMMAND CLASSES

The following table lists all Command Classes supported by the Z-Wave device. The device supports S0, S2 Authenticated security and S2 Unauthenticated security.

| ASSOCIATION | VERSION | INSECURE INCLUSION | INSECURE ON SECURE INCLUSION | SECURE ON SECURE INCLUSION |
|-------------------------------|---------|--------------------|------------------------------|----------------------------|
| Association Group Information | V3 | Yes | | Yes |
| Device Reset Locally | V1 | Yes | | Yes |
| Firmware Update Meta Data | V5 | Yes | | Yes |
| Indicator | V3 | Yes | | Yes |
| Manufacturer Specific | V2 | Yes | | Yes |
| Multi Channel Association | V3 | Yes | | Yes |
| Powerlevel | V1 | Yes | | Yes |
| Security | V1 | Yes | Yes | |
| Security 2 | V1 | Yes | Yes | |
| Supervision | V1 | Yes | Yes | |
| Transport Service | V2 | Yes | Yes | |
| Version | V3 | Yes | | Yes |
| Z-Wave Plus Info | V2 | Yes | Yes | |
| Meter | V5 | Yes | | Yes |
| Configuration | V4 | Yes | | Yes |
| Multilevel Sensor | V11 | Yes | | Yes |
| Association | V2 | Yes | | Yes |

PRODUCT INFO Heatit Z-HAN B

FEATURES

- Z-Wave HAN sensor
- RJ45 and Micro-USB
- Power metering
- SmartStart
- Firmware update (OTA)
- Temperature sensor
- Supports encryption mode S0, S2 Authenticated Class, S2 Unauthenticated Class

The product must be used with a security-enabled Z-Wave Controller in order to fully utilize security/encryption.

TECHNICAL DATA

| | |
|---------------------|------------------|
| Protocol | Z-Wave, 868.4MHz |
| Chip | Z-Wave 700 chip |
| Rated voltage | 5V DC |
| Ambient temperature | 5°C to 40°C |
| Humidity | 10% to 85% RH |
| Range RF | Min. 40 meter |
| IP Code | IP 20 |
| Size (LxWxH) | 80 x 31 x 22mm |

| | |
|-----------|--------------------|
| Approvals | Z-Wave Plus v2, CE |
|-----------|--------------------|

MAINTENANCE

The device is maintenance-free. Only for indoor installation.

| ART. NO. | PRODUCT | COLOR | FREQUENCY |
|-----------|----------------|----------------------|-------------|
| 45 124 96 | Heatit Z-HAN B | Black Olive RAL 6015 | EU 868.4MHz |

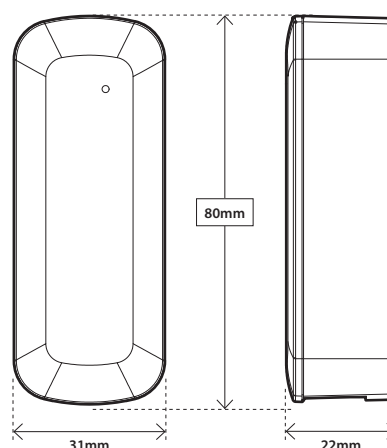

DISPOSAL GUIDELINES

Do not dispose of electrical appliances as unsorted municipal waste, use separate collection facilities. Contact your local government for information regarding the collection systems available. If electrical appliances are disposed of in landfills or dumps, hazardous substances can leak into the groundwater and get into the food chain, damaging health and well-being.



Heatit Controls AB can not be held liable for typographical errors, other errors or omissions in our information. Product specifications may change without further notice. All electrical installations must be carried out by a licensed electrician. The product must be installed in accordance with national building codes and our installers manual.